



深圳市一众显示科技有限公司

SHEN ZHEN TEAM SOURCE DISPLAYTECH. CO, TD.

TFT-LCD Module Specification

Module NO.: TST084WSTH-B01

Version: V1.0

APPROVAL FOR SPECIFICATION

APPROVAL FOR SAMPLE

| For Customer' s Acceptance: | |
|-----------------------------|---------|
| Approved by | Comment |
| | |

| Team Source Display: | | |
|----------------------|-------------|--------------|
| Presented by | Reviewed by | Organized by |
| | | |

| Version No. | Date | Content | Remark |
|-------------|------------|----------------|--------|
| V1.0 | 2021-07-10 | First Released | |
| | | | |

1 General Specifications

| | Feature | Spec |
|-----------------------------------|----------------------|--|
| Display Spec. | Size (inch) | 8.4 |
| | Resolution | 1024x768 |
| | Technology Type | a-Si |
| | Pixel Configuration | R.G.B. Vertical Stripe |
| | Pixel pitch(mm) | 0.1665 x 0.1665 |
| | Display Mode | SFT, Normally Black |
| | Surface Treatment | AG |
| | Viewing Direction | All Direction |
| Mechanical Characteristics | LCM (W x H x D) (mm) | 199.5x149x9.7 |
| | Active Area(mm) | 170.496*127.872 |
| | With /Without TP | Without |
| | Matching Connection | CN1 : FI-SEB20P-HFE CN2 : FI-S6P-HFE(JAE) |
| | LED Numbers | 21 LEDs |
| | Weight (g) | 301 |
| Electrical Characteristics | Interface | LVDS |
| | Color Depth | 16.7 Million color/262 Kilo color |

Note 1: Requirements on Environmental Protection: Q/S0002.

Note 2: LCM weight tolerance: ± 5%

2 Input/Output Terminals

2.1 LCD Interface PINs

Matching Connector: FI-SEB20P-HFE

| Pin No. | Symbol | I/O | Function | Remark |
|---------|--------|-----|--|--------|
| 1 | VCC | P | 3.3V power supply | - |
| 2 | VCC | P | 3.3V power supply | - |
| 3 | GND | P | Ground | Note2 |
| 4 | GND | P | Ground | Note2 |
| 5 | Link0- | I | Negative LVDS differential data input | |
| 6 | Link0+ | I | Positive LVDS differential data input | |
| 7 | GND | P | Ground | Note2 |
| 8 | Link1- | I | Negative LVDS differential data input | |
| 9 | Link1+ | I | Positive LVDS differential data input | |
| 10 | GND | P | Ground | Note2 |
| 11 | Link2- | I | Negative LVDS differential data input | |
| 12 | Link2+ | I | Positive LVDS differential data input | |
| 13 | GND | P | Ground | Note2 |
| 14 | CLKIN- | I | Negative LVDS differential data input | |
| 15 | CLKIN+ | I | Positive LVDS differential data input | |
| 16 | GND | P | Ground | Note2 |
| 17 | Link3- | I | Negative LVDS differential data input | Note3 |
| 18 | Link3+ | I | Positive LVDS differential data input | Note3 |
| 19 | MODE | I | 6-bit / 8-bit input select for LVDS interface. High : 8bit. Low or Open : 6bit. | |
| 20 | SC | I | Reverse Scan control Low or Open: Normal scan High : Reverse scan | Note4 |

Note1:I---Input, O---Output, P--- Power/Ground

Note2: All of the GND Pins should be connected to the system ground.

Note3: Please set to GND if pin is NOT in use.

Note4: The function of the SC. The figure below is a front view.

2.2 CN2 pin assignment (Backlight interface)

Matching Connector type: FI-S6P-HFE(JAE)

| Pin | Symbol | I/O | Description | Remark |
|-----|-------------------|-----|--|--------|
| 1 | VL | P | Power Supply Input Voltage | - |
| 2 | VL | P | Power Supply Input Voltage | - |
| 3 | GND | P | GND | - |
| 4 | GND | P | GND | - |
| 5 | BLEN | I | Backlight ON-OFF (High : ON, Low : OFF) | - |
| 6 | V _{PDIM} | I | Light Dimming Control (PWM)Input Voltage | - |

3 Absolute Maximum Ratings

GND=0V

| Item | Symbol | MIN | MAX | Unit | Remark |
|----------------------------|--------|------|------|------------------|------------------|
| Power Voltage | VCC | -0.3 | 5 | V | |
| Input voltage | VIN | -0.3 | 5 | V | Note1 |
| Backlight Power Voltage | VL | -0.3 | 26.5 | V | |
| Backlight Input voltage | VBLIN | -0.3 | 26.5 | V | Note2 |
| Operating Temperature | Top | -30 | 80 | °C | - |
| Storage Temperature | Tst | -40 | 90 | °C | - |
| Relative Humidity Note2 | RH | -- | ≤95 | % | Ta≤40°C |
| | | -- | ≤85 | % | 40°C < Ta ≤ 50°C |
| | | -- | ≤55 | % | 50°C < Ta ≤ 60°C |
| | | -- | ≤36 | % | 60°C < Ta ≤ 70°C |
| | | -- | ≤24 | % | 70°C < Ta ≤ 80°C |
| Absolute Humidity | AH | -- | ≤70 | g/m ³ | Ta > 70°C |

Table 3.1 Absolute Maximum Ratings

Note1: Input voltage include MODE,SC, Link0-/+, Link1-/+, Link2-/+, Link3-/+,VCC.

Note2: Backlight Input voltage include BLEN, V_{PDIM}.

Note2: Ta means the ambient temperature.

It is necessary to limit the relative humidity to the specified temperature range.

Condensation on the module is not allowed.

4 Electrical Characteristics

4.1 Driving TFT LCD Panel

VCC=3.3V, GND=0V, Ta = 25°C

| Item | Symbol | MIN | TYP | MAX | Unit | Remark |
|--|-----------------|---------|------|--------------------------|------|--------|
| Power supply voltage | VCC | 3.2 | 3.3 | 3.4 | V | |
| Power Ground | GND | - | 0 | - | V | |
| Input High Voltage | VIH | 0.7xVCC | | VCC | V | Note1 |
| Input Low Voltage | VIL | GND | | 0.3xVCC | V | |
| LVDS differential input high threshold voltage | RxVTH | - | - | +200 | mV | Note2 |
| LVDS differential input low threshold voltage | RxVTL | -200 | - | - | | |
| Differential input voltage | V _{id} | 200 | - | 600 | mV | |
| Differential input common mode voltage | RxVCM | 1.0 | 1.2 | $1.7 \cdot V_{id} / 2$ | V | |
| Current of VCC Power supply | IVCC | - | 310 | - | mA | Note3 |
| Power consumption | P | - | 1023 | - | mW | |
| Inrush current of VCC | Irush | - | TBD | TBD | A | Note4 |

Tble 4.1 LCD electrical characteristics

Note1: Including MODE,SC.

Note2: Refers to the LVDS waveform as shown below

Note3: Test pattern in white

Note4:VCC rising time >1ms.

Single-end Signal

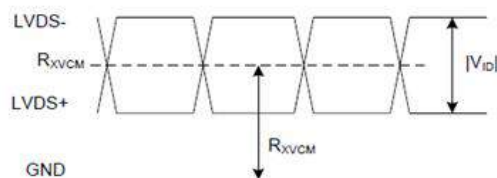

Differential Signal

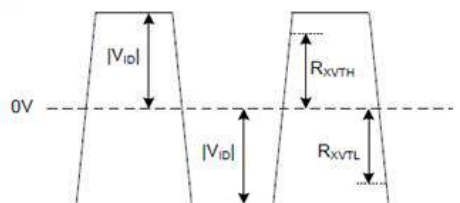

LVDS DC Diagram

Figure4.1 LVDS DC Diagram

4.2 Backlight Unit Driving Condition

GND=0V, Ta = 25°C

| Parameter | Symbol | min. | typ. | max. | Unit | Remarks |
|--|-------------------|-----------------|-------|------|----------------|-------------|
| Power supply voltage | VL | 10.8 | 12.0 | 13.2 | V | Note1,Note3 |
| Power supply current | IVL | - | 385 | - | mA | Note2 |
| Power consumption of Backlight | P | - | 4620 | - | mW | |
| Input voltage for V _{PDIM} (PWM) signal | High | V _{IH} | 1.3 | - | V _L | - |
| | Low | V _{IL} | 0 | - | 0.5 | |
| Input voltage for BLEN signal | High | V _{IH} | 1.3 | - | V _L | |
| | Low | V _{IL} | 0 | - | 0.5 | |
| V _{PDIM} (PWM) frequency | f _{PWM} | 100 | - | 1000 | Hz | |
| V _{PDIM} (PWM) duty ratio | DR _{PWM} | 1 | - | 100 | % | |
| LED Life time | LT | - | 50000 | -- | Hrs | |

Table 4.2 LED backlight characteristics

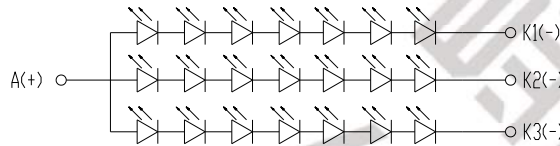

Figure 4.2 LED connection of backlight

- Note1: When designing of the power supply, take the measures for the prevention of surge voltage.
- Note2: This value excludes peak current such as overshoot current. At the maximum luminance control.
- Note3: The power supply lines (VL and GND) may have ripple voltage during luminance control of LED. There is the possibility that the ripple voltage produces acoustic noise and signal wave noise in audio circuit and so on.

4.3 BLOCK DIAGRAM

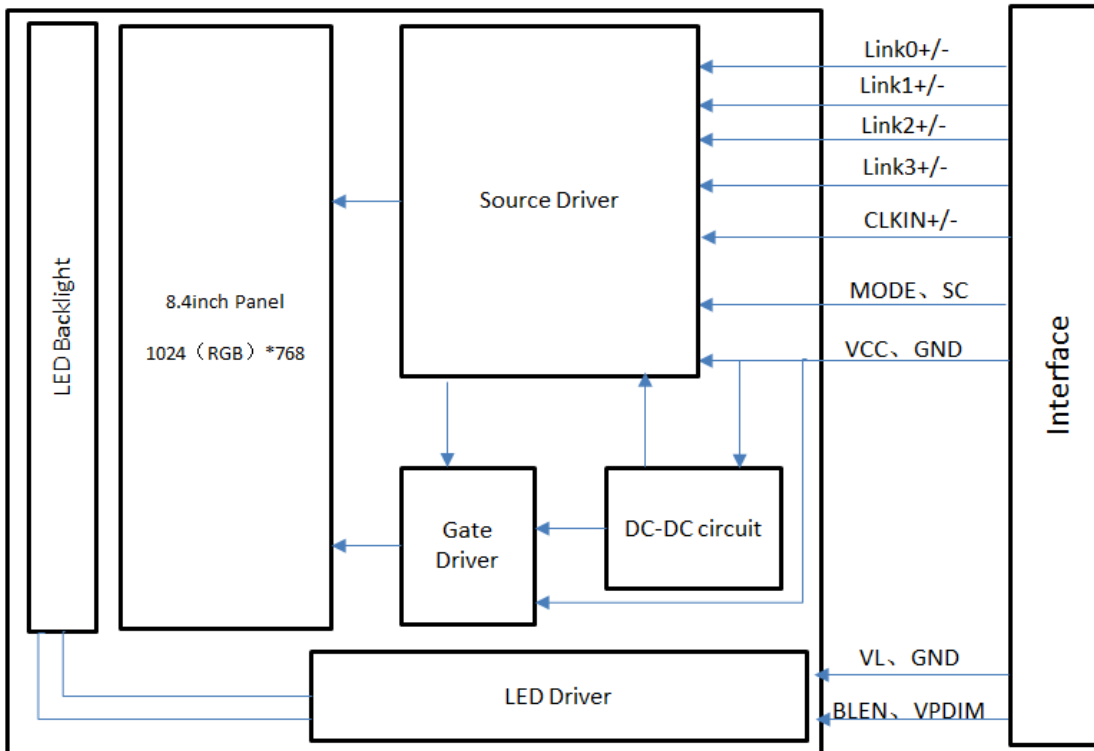
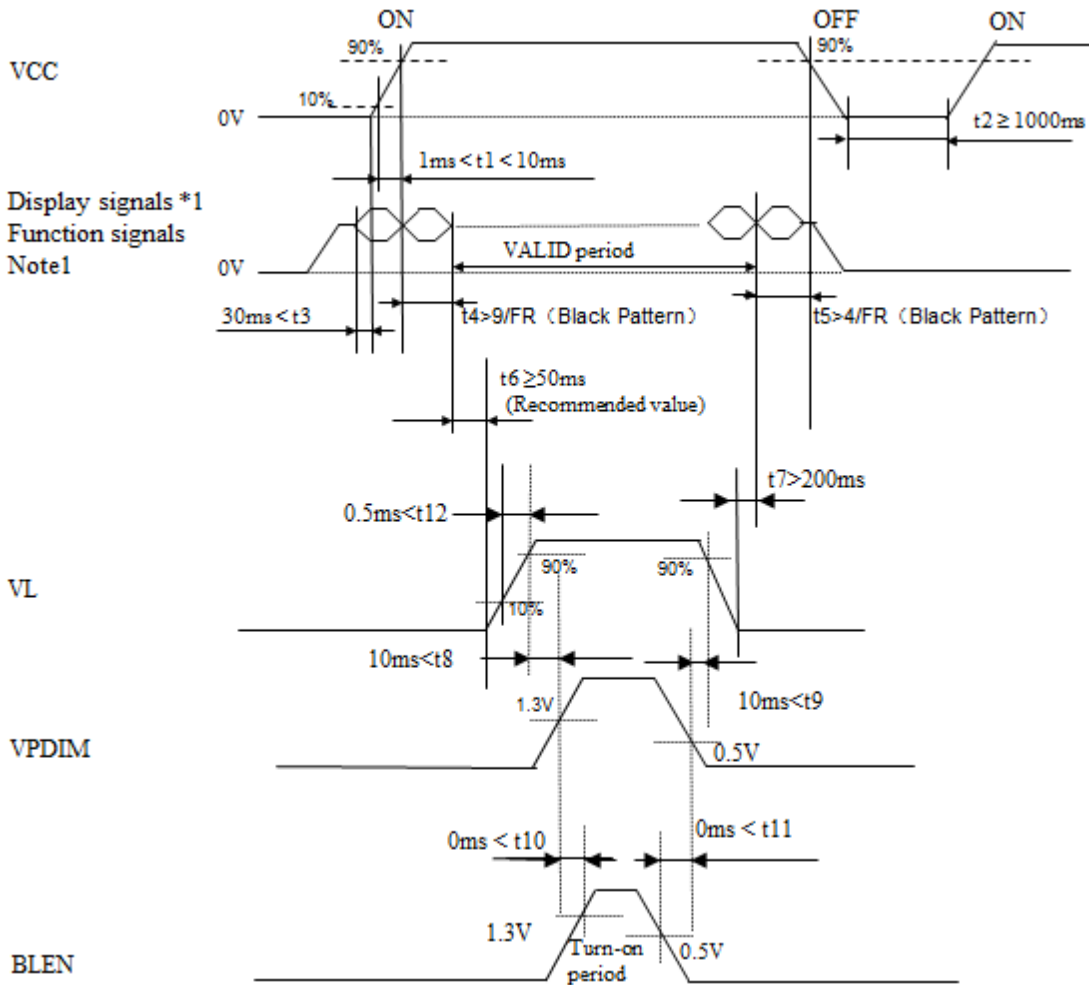

Figure 4.3 LCD Module Block Diagram

4.4 LCD panel Power ON / OFF sequence



*1: Link0+/-, Link1+/-, Link 2+/-, Link 3+/-, CLKIN+/-

Figure 4.4 Power ON/OFF sequence

Note1: If some of display and function signals of this product are cut while this product is working, even if the signal input to it once again, it might not work normally. If a customer stops the display and function signals, VCC also must be shut down.

Note2: The backlight should be turned on within the valid period of display and function signals, in order to avoid unstable data display.

Note3: FR=Frame rate=60Hz.

5 Timing Chart

5.1 LVDS Interface Timing Characteristics

5.1.1 LVDS Input Data Format 8-bit LVDS VESA

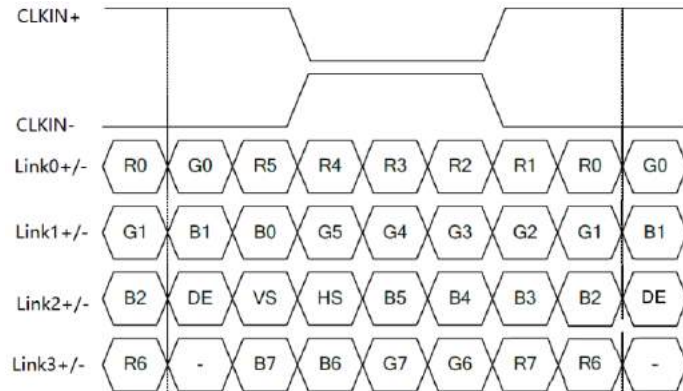

Figure 5.1.1 LVDS data map

5.1.2 LVDS Input Data Format 6-bit LVDS VESA

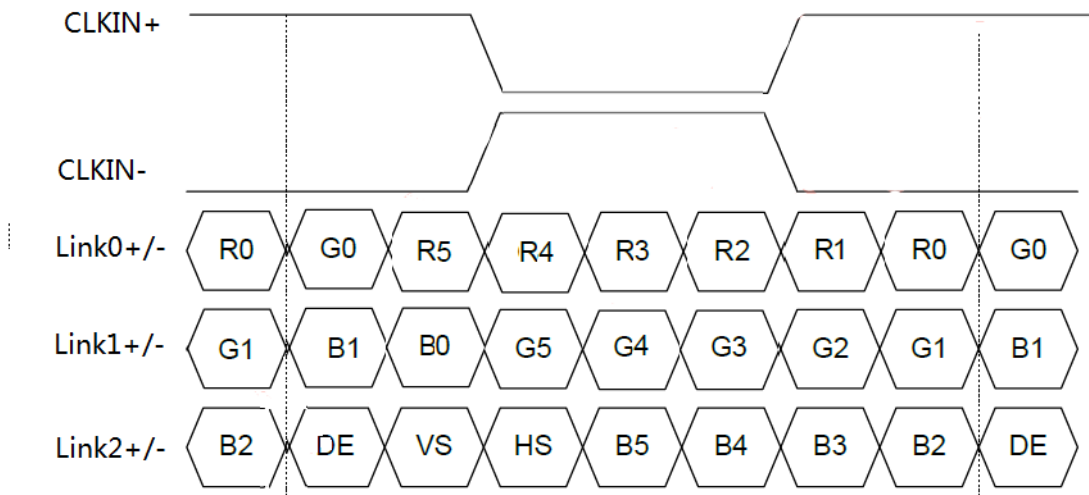

Figure5.1.1 LVDS data map

5.2 Input Timing Table

DE mode for 1024RGB*768

| Parameter | Symbol | Min. | Typ. | Max. | Unit |
|-------------------------|-----------|------|------|------|------|
| CLKIN+/- frequency | FCLK | 50.3 | 50.7 | 65.3 | MHz |
| Horizontal display area | THD | 1024 | | | CLK |
| HS period time | TH | 1084 | 1088 | 1214 | CLK |
| HS blanking | THFP+THBP | 60 | 64 | 190 | CLK |
| Vertical display area | TVD | 768 | | | H |
| VS period time | TV | 774 | 776 | 897 | H |
| VS blanking | TVBP+TVFP | 6 | 8 | 129 | H |

Table 5.2 LVDS data parameters

5.3 LVDS Input Timing Format

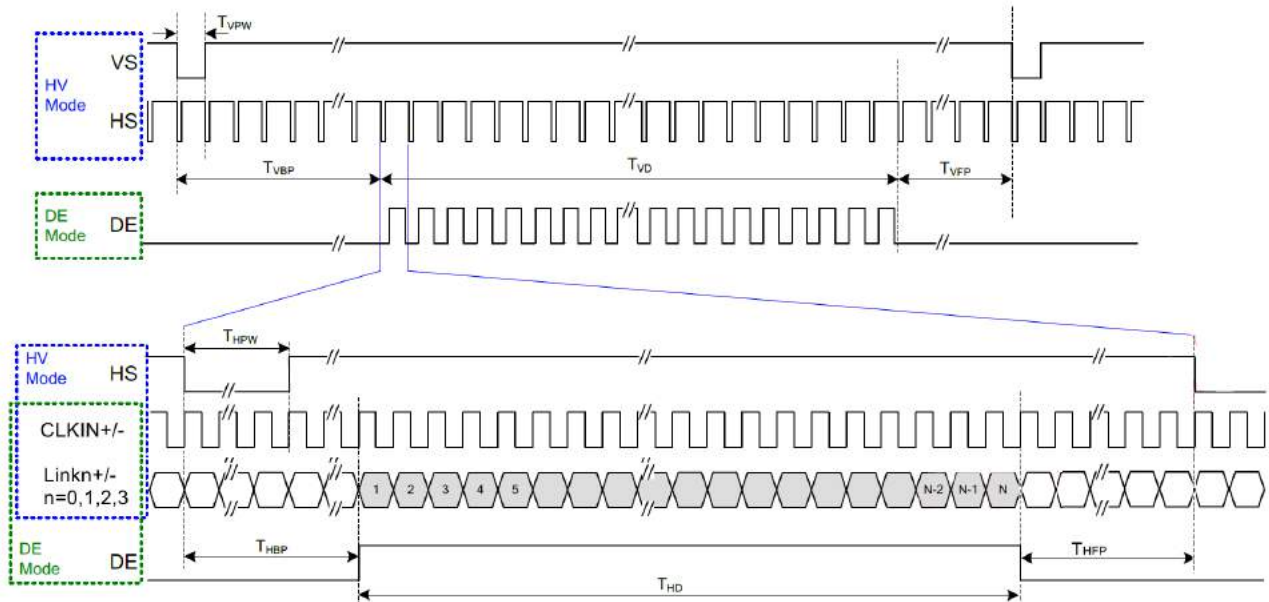

Figure 5.3 Recommended input timing of LVDS transmitter

Note1: As shown in the figure above, the customer only needs to look at the DE mode section instead of the SYNC section.

5.4 LVDS interface AC characteristic

| Parameter | Symbol | Min. | Typ. | Max. | Unit | Condition |
|------------------------|--------|-------|------------------|------|---------|--|
| Clock frequency | FLVCLK | 25 | - | 85 | MHz | Refer to input timing table for each display resolution. |
| Clock Period | TLVCLK | 11.76 | - | 40 | nsec | |
| Clock high time | TLVCH | - | $4/(7 * RXFCLK)$ | - | ns | |
| Clock low time | TLVCL | - | $3/(7 * RXFCLK)$ | - | ns | |
| Input data skew margin | TRSKM | - | - | 0.25 | UI | $VCC_IF=1.8V$ w/o SSC |
| Strobe width | TSW | 0.5 | - | - | UI | |
| 1 data bit time | UI | - | 1/7 | - | TLV CLK | |
| Position 1 | TPOS1 | -0.25 | 0 | 0.25 | UI | |
| Position 0 | TPOS0 | 0.75 | 1 | 1.25 | UI | |
| Position 6 | TPOS6 | 1.75 | 2 | 2.25 | UI | |
| Position 5 | TPOS5 | 2.75 | 3 | 3.25 | UI | |
| Position 4 | TPOS4 | 3.75 | 4 | 4.25 | UI | |
| Position 3 | TPOS3 | 4.75 | 5 | 5.25 | UI | |
| Position 2 | TPOS2 | 5.75 | 6 | 6.25 | UI | |

Table 5.4 LVDS interface AC characteristic

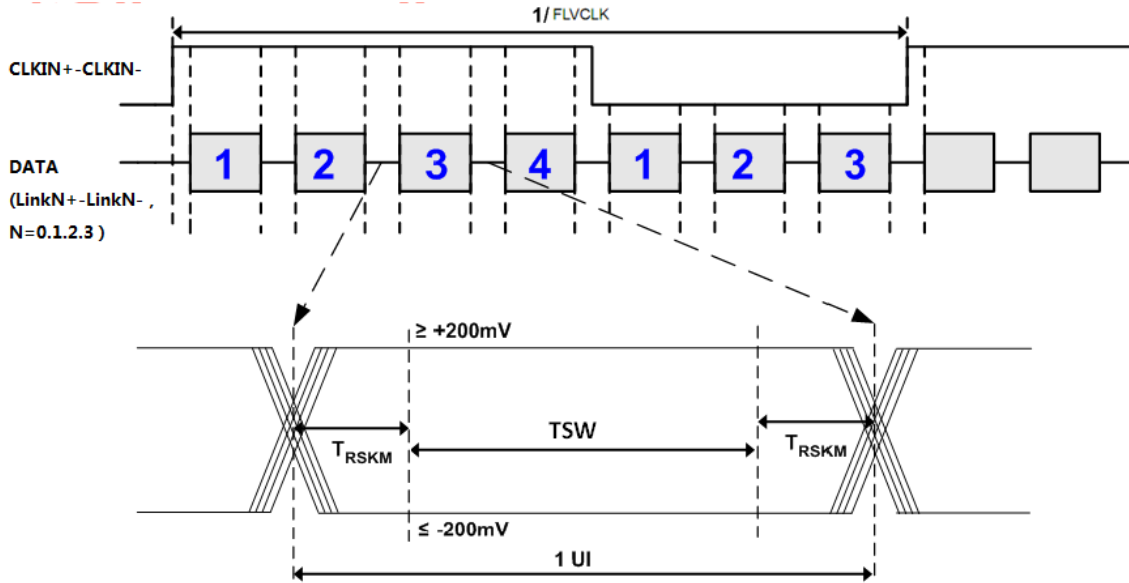

Figure 5.4.1 LVDS Data Skew

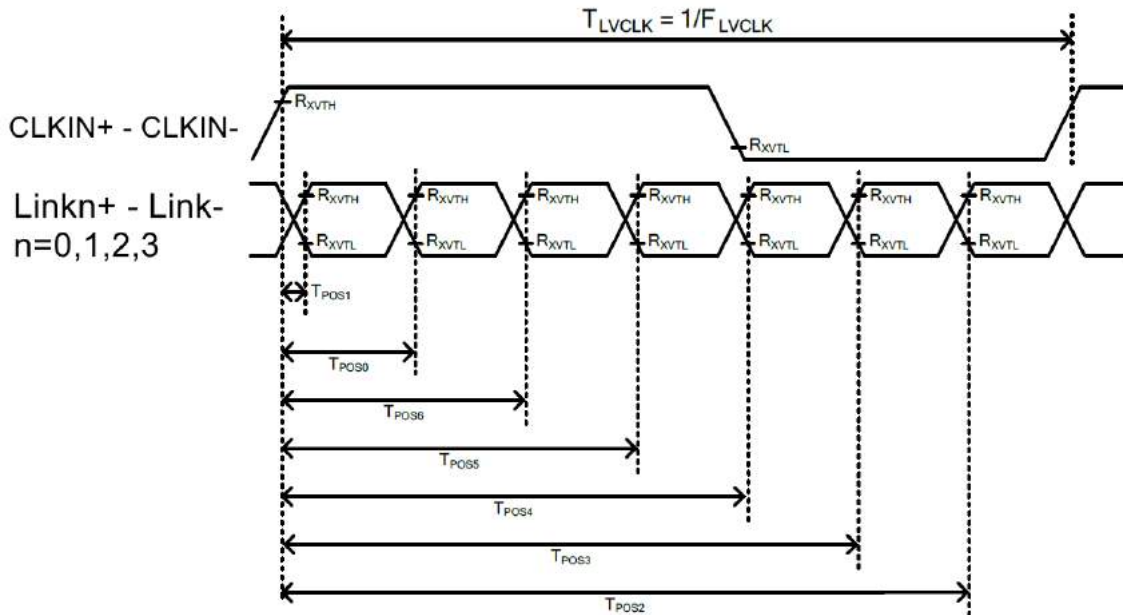

Figure 5.4.2 LVDS input timing

6 Optical Characteristics

| Item | Symbol | Condition | Min | Typ | Max | Unit | Remark |
|----------------------|------------|------------------|-----|-------|-------|-------------------|----------|
| View Angles | θT | $CR \geq 10$ | 80 | 88 | -- | Degree | Note2,3 |
| | θB | | 80 | 88 | -- | | |
| | θL | | 80 | 88 | -- | | |
| | θR | | 80 | 88 | -- | | |
| Contrast Ratio | CR | $\theta=0^\circ$ | 800 | 1000 | -- | | Note 3 |
| Response Time | T_{ON} | 25°C | -- | 25 | 30 | ms | Note 4 |
| | T_{OFF} | | | | | | |
| Chromaticity | White | Backlight is on | x | 0.239 | 0.289 | 0.339 | Note 1,5 |
| | | | y | 0.258 | 0.308 | 0.358 | |
| | Red | | x | 0.580 | 0.630 | 0.680 | Note 1,5 |
| | | | y | 0.281 | 0.331 | 0.381 | |
| | Green | | x | 0.252 | 0.302 | 0.352 | Note 1,5 |
| | | | y | 0.575 | 0.625 | 0.675 | |
| | Blue | | x | 0.103 | 0.153 | 0.203 | Note 1,5 |
| | | | y | 0.012 | 0.062 | 0.112 | |
| Luminance Uniformity | U | | 75 | 85 | | % | Note 6 |
| NTSC | | | 65 | 70 | -- | % | Note 5 |
| Luminance | L | | 500 | 600 | | cd/m ² | Note 7 |

Test Conditions:

1. $I_F = 80$ mA, and the ambient temperature is 25°C.
2. The test systems refer to Note 1 and Note 2.

Note 1: Definition of optical measurement system.

The optical characteristics should be measured in dark room. After 5 Minutes operation, the optical properties are measured at the center point of the LCD screen. All input terminals LCD panel must be ground when measuring the center area of the panel.

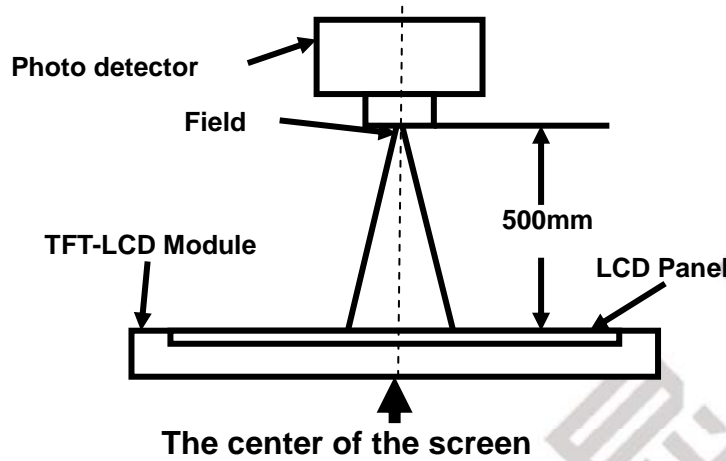
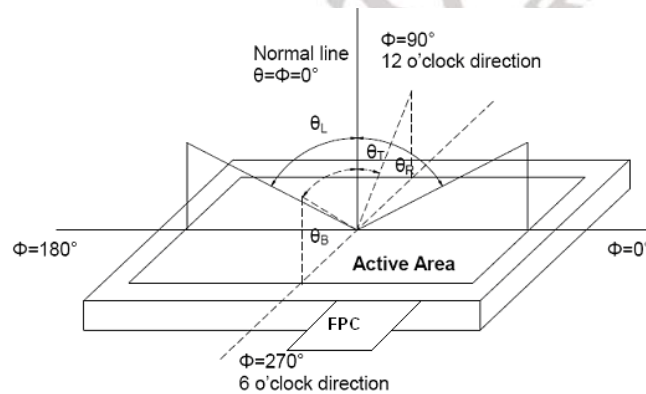

Figure 6.1 Definition of optical measurement system

Note 2: Definition of viewing angle range and measurement system.

viewing angle is measured at the center point of the LCD .



Note 3: Definition of contrast ratio

$$\text{Contrast ratio (CR)} = \frac{\text{Luminance measured when LCD is on the "White" state}}{\text{Luminance measured when LCD is on the "Black" state}}$$

“White state “: The state is that the LCD should drive by V_{white} .

“Black state“: The state is that the LCD should drive by V_{black} .

V_{white} : To be determined V_{black} : To be determined.

Note 4: Definition of Response time

The response time is defined as the LCD optical switching time interval between “White” state and “Black” state. Rise time (T_{ON}) is the time between photo detector output intensity changed from 90% to 10%. And fall time (T_{OFF}) is the time between photo detector output intensity changed from 10% to 90%.

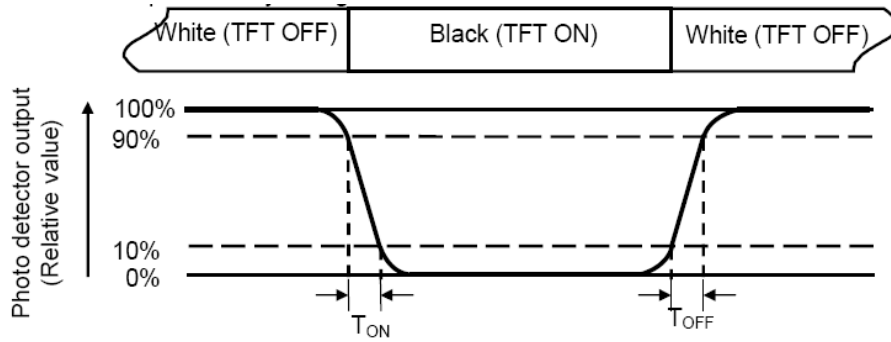

Note 5: Definition of color chromaticity (CIE1931)

Color coordinates measured at center point of LCD.

Note 6: Definition of Luminance Uniformity

Active area is divided into 9 measuring areas (Refer Fig. 2). Every measuring point is placed at the center of each measuring area.

$$\text{Luminance Uniformity (U)} = \text{Lmin} / \text{Lmax}$$

L-----Active area length

W----- Active area width

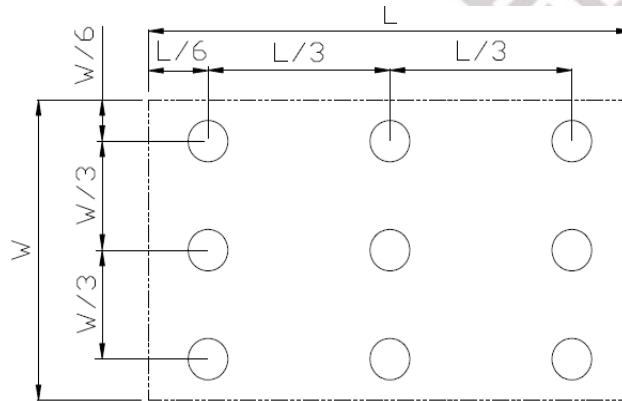

Figure 6.3 Definition of uniformity

Lmax: The measured Maximum luminance of all measurement position.

Lmin: The measured Minimum luminance of all measurement position.

Note 7: Definition of Luminance:

Measure the luminance of white state at center point.

7 Environmental / Reliability Test

| No | Test Item | Condition | Remarks |
|----|--|---|---|
| 1 | High Temperature Operation | Ta = +80°C ,500 hours | IEC60068-2-1 GB2423.2 |
| 2 | Low Temperature Operation | Ta = -30°C , 500 hours | IEC60068-2-1 GB2423.1 |
| 3 | High Temperature Storage | Ta = +90°C , 500 hours | IEC60068-2-1 GB2423.2 |
| 4 | Low Temperature Storage | Ta = -40°C , 500 hours | IEC60068-2-1 GB2423.1 |
| 5 | Storage at High Temperature and Humidity | Ta = +60°C , 90% RH max,500hours | IEC60068-2-78 GB/T2423.3 |
| 6 | Thermal Shock (non-operation) | -30°C 30 min~+80°C 30 min, Change time:5min, 100 Cycle | Start with cold temperature, End with high temperature, IEC60068-2-14,GB2423.22 |
| 7 | ESD | C=150pF,R=330Ω,5point/panel Air:±15Kv,5times; Contact:±8Kv,5times (Environment:15°C~35°C, 30%~60%.86Kpa~106Kpa) | IEC61000-4-2 GB/T17626.2 |
| 8 | Vibration Test (Non Op) | 5~100HZ, 19.60m/s ² 1min/cycle 120times Per X\Y\Z | IEC60068-2-6 GB/T17626.6 |
| 9 | Mechanical Shock (Non Op) | 539m/s ² , 11ms 5times ±X、±Y、±Z | IEC60068-2-27 GB/T2423.5 |

Note1: Ts is the temperature of panel's surface.

Note2: Ta is the ambient temperature of sample.

Note3: Before cosmetic and function test, the product must have enough recovery time, at least 2 hours at room temperature.

Note 4: In the standard condition, there shall be no practical problem that may affect the display function. After the reliability test, only guarantee the operation of the product,but don't guarantee all of the cosmetic specification.

8 Mechanical Drawing

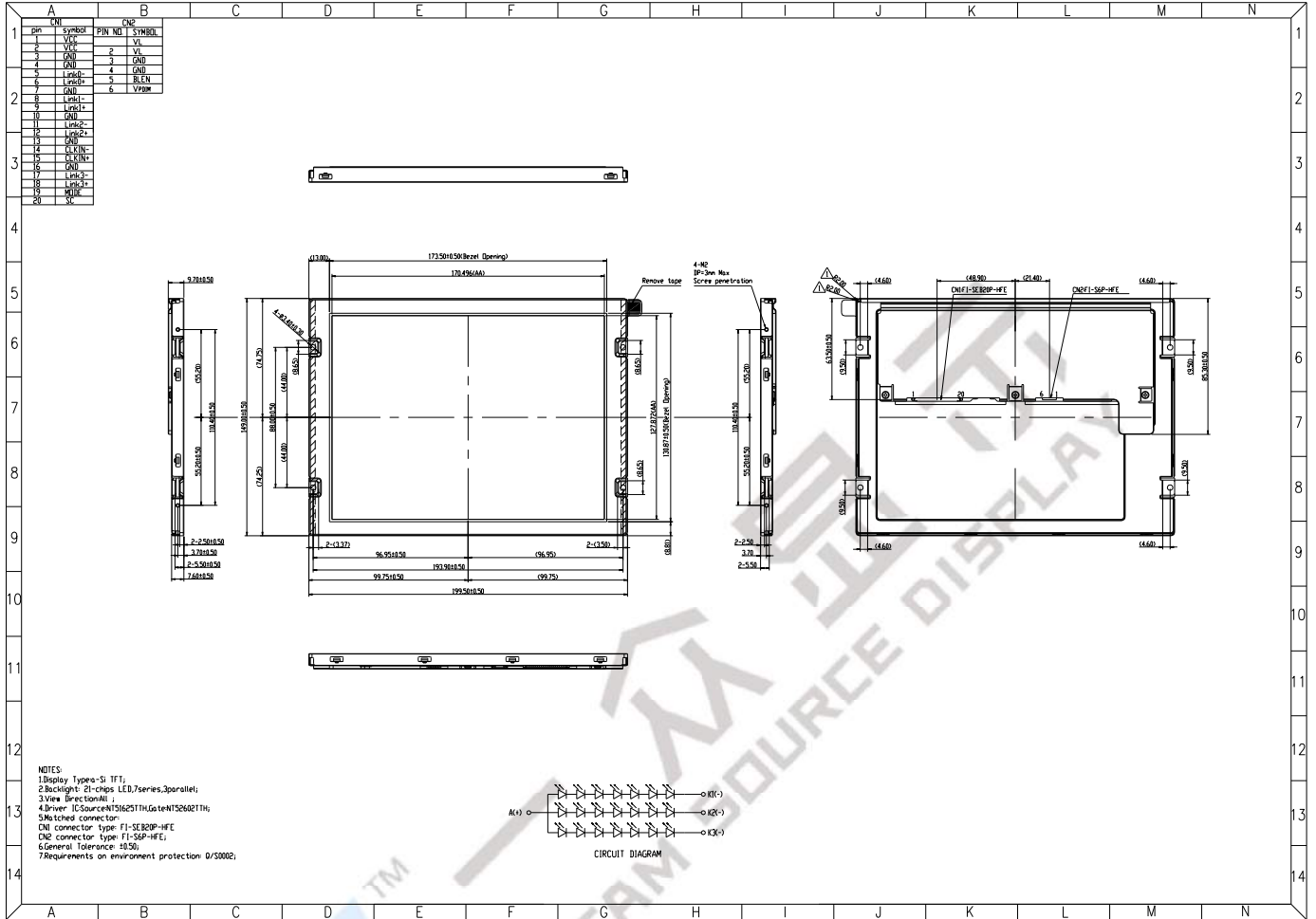

9 Packing Drawing

TBD

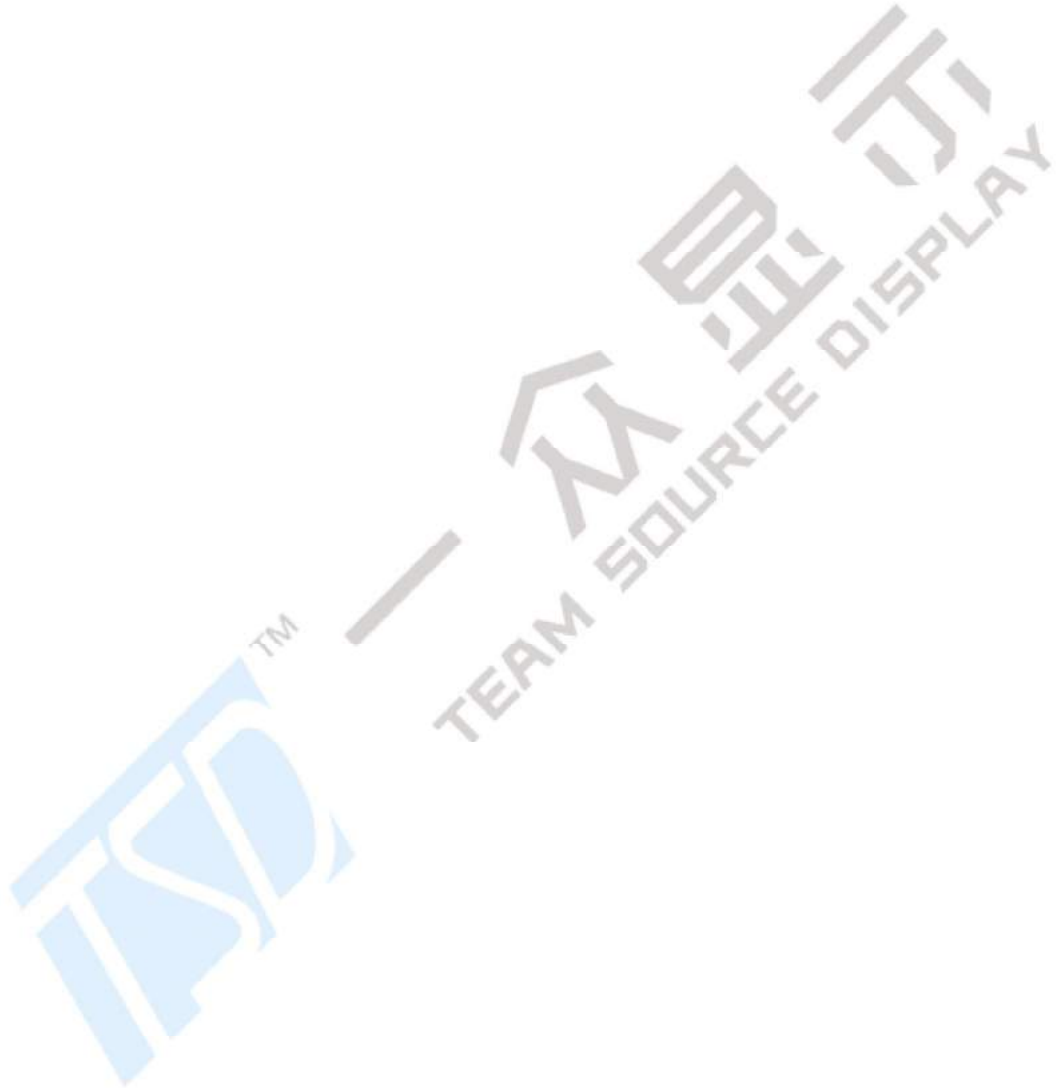

10 Precautions for Use of LCD Modules

a) Handling Precautions

- i. The display panel is made of glass. Do not subject it to a mechanical shock by dropping it from a high place, etc.
- ii. If the display panel is damaged and the liquid crystal substance inside it leaks out, be sure not to get any in your mouth, if the substance comes into contact with your skin or clothes, promptly wash it off using soap and water.
- iii. Do not apply excessive force to the display surface or the adjoining areas since this may cause the color tone to vary.
- iv. The polarizer covering the display surface of the LCD module is soft and easily scratched. Handle this polarizer carefully.
- v. If the display surface is contaminated, breathe on the surface and gently wipe it with a soft dry cloth. If still not completely clear, moisten cloth with one of the following solvents:
 - Isopropyl alcohol
 - Ethyl alcohol

Solvents other than those mentioned above may damage the polarizer. Especially, do not use the following:

- Water
 - Ketone
 - Aromatic solvents
- vi. Do not attempt to disassemble the LCD Module.
 - vii. If the logic circuit power is off, do not apply the input signals.
 - viii. To prevent destruction of the elements by static electricity, be careful to maintain an optimum work environment.

10.1.8.1 Be sure to ground the body when handling the LCD Modules.

10.1.8.2 Tools required for assembly, such as soldering irons, must be properly ground.

10.1.8.3 To reduce the amount of static electricity generated, do not conduct assembly and other work under dry conditions.

10.1.8.4 The LCD Module is coated with a film to protect the display surface. Be care when peeling off this protective film since static electricity may be generated.

b) Storage precautions

- i. When storing the LCD modules, avoid exposure to direct sunlight or to the light of fluorescent lamps.
- ii. The LCD modules should be stored under the storage temperature range. If the LCD modules will be stored for a long time, the recommend condition is:

Temperature : 0°C ~ 40°C Relatively humidity: ≤80%

- iii. The LCD modules should be stored in the room without acid, alkali and harmful gas.

c) Transportation Precautions

- i. The LCD modules should be no falling and violent shocking during transportation, and also should avoid excessive press, water, damp and sunshine.