



一众显示科技有限公司

TEAM SOURCE DISPLAY TECH. CO, TD.

TFT-LCD Module Specification

Module NO.: TST103HDKK-02

Version: V1.1

APPROVAL FOR SPECIFICATION

APPROVAL FOR SAMPLE

For Customer' s Acceptance:	
Approved by	Comment

Team Source Display:		
Presented by	Reviewed by	Approved by

Version No.	Date	Content	Remark
V1.0	2022-7-19	Initial Release	
V1.1	2022-8-09	Modify the format	
V1.1	2022-8-25	Fixed size	Page3

CONTENTS

1 GENERAL DESCRIPTION - 3 -

2 ABSOLUTE MAXIMUM RATINGS - 3 -

3 OPTICAL CHARACTERISTICS - 4 -

4 BLOCK DIAGRAM - 6 -

5 INTERFACE PIN CONNECTION - 7 -

6 ELECTRICAL CHARACTERISTICS - 8 -

 6.1 ABSOLUTE MAXIMUM RATINGS - 8 -

 6.2 DC ELECTRICAL CHARACTERISTICS - 9 -

 6.3 MEASUREMENT CONDITIONS - 10 -

 6.4 SIGNAL TIMING SPECIFICATION - 10 -

 6.5 SIGNAL ELECTRICAL CHARACTERISTICS FOR LVDS RECEIVER - 10 -

 6.6 POWER SEQUENCE - 12 -

 6.7 DC CHARACTERISTICS BACKLIGHT DRIVING - 12 -

7 RELIABILITY TEST ITEMS - 17 -

8 OUTLINE DIMENSION - 18 -

9 ABOUT IMAGE STICKING - 19 -

 9.1.1 WHAT IS IMAGE STICKING? - 19 -

 9.1.2 WHAT CAUSES IMAGE STICKING? - 19 -

 9.1.3 HOW TO AVOID IMAGE STICKING? - 19 -

 9.1.4 HOW TO FIX THE IMAGE STICKING? - 20 -

 9.1.5 IS IMAGE STICKING COVERED BY TSD RMA WARRANTY? - 20 -

 9.2 OTHERS - 20 -

10 SUGGESTIONS FOR USING LCD MODULES - 20 -

 10.1 HANDLING OF LCM - 20 -

 10.2 STORAGE - 21 -

11 LIMITED WARRANTY - 21 -

1 GENERAL DESCRIPTION

1.1 Introduction

This is a color active matrix thin film transistor (TFT) liquid crystal display (LCD) that uses a-Si and transmissive TFT as a switching device with normal-black technology. It is composed of a TFT LCD panel, driver IC and back-light. The TFT LCD has 10.3 inch with 1920 x 720 resolution and RoHS directive.

1.2 Features

10.3 (8:3 diagonal) inch configuration

Landscape type

Fail detect function

Parallel RGB 8 bits (16.7M)

1.3 Applications

TFT LCD Monitor

Industrial Application

Amusement

Vehicle

1.4 General information

Item	Specification	Unit
Diagonal Size	10.3	Inch
Resolution	1920 (H)×720(V)	pixels
Active area(mm)	243.65(H)×91.37(V)	mm
Pixel pitch(mm)	0.1269(H) ×0.1269(V)	mm
Pixel Configuration	RGB Vertical stripe	
Display mode	Normally Black	
Technology Type	a-Si	
NTSC	70%(Min.) / 75%(Typ.)	%
Surface treatment	HC	
Border (U/D/L/R)	4.58 / 9.45 / 4.25 / 6.25	mm
Back-light	White LED	
Outline Dimension	253.15(H) x106.01(V) x 6.81 (D) (Typ.)	mm
Weight	230.3+/- 5%	g

2 ABSOLUTE MAXIMUM RATINGS

Environment Absolute Rating

Item	Symbol	Min.	Max.	Time	Note
Operating Temperature	T _{opa}	-30℃	85℃	500 hrs	
Storage Temperature	T _{stg}	-40℃	90℃	500 hrs	

3 OPTICAL CHARACTERISTICS

Optical specification

Item	Symbol	Condition	Min.	Typ.	Max.	Unit	Note	
View Angles	Θ_{x+}	$CR \geq 10$ $\theta_x=0^\circ$, $\theta_y=0^\circ$	80	85	-	Degree	(4)	
	Θ_{x-}		80	85	-			
	Θ_{y+}		80	85	-			
	Θ_{y-}		80	85	-			
Contrast Ratio	CR	$\Theta=0^\circ$	1200:1	1500:1			(2)	
Response time	$T_g=25^\circ\text{C}$		-	-	(30)	ms	(3)	
	$T_g=-20^\circ\text{C}$		-	-	(250)	ms		
	$T_g=-30^\circ\text{C}$		-	-	(450)	ms		
Only CF Color Chromaticity(CIE1931) Under C-light	White	W_x	Backlight is on	+/- 0.04	(0.300)	+/- 0.04	-	(1)
		W_y			(0.320)			
	Red	R_x			(0.657)			
		R_y			(0.320)			
	Green	G_x			(0.283)			
		G_y			(0.606)			
	Blue	B_x			(0.138)			
		B_y			(0.104)			
Uniformity	U		80	85	--	%	(1)	
NTSC	--		70	75	--	%	(1)	
Luminance	L	-	800	1000	--	cd/m	(1)	

Notes :

(1) The chromaticity coordinates specified in Table 5 should be calculated from the measurement spectrum of all pixels in red, green, blue, and white, which need to be converted to C-light standard light source, and should be measured at the center of the panel.

(2) Definition of Contrast Ratio (CR): The contrast ratio can be calculated by the

-4-

following expression,

Contrast Ratio (CR): $CR=CR_wCRD$

CRW : Luminance of LCD module with full screen white pattern (255,255, 255)

at center point.

CRD : Luminance of LCD module with full screen Dark pattern (0, 0, 0) at center point.

The measure point of the Contrast Ratio is the center of the panel.

(3) Definition of Response time (RT):

The response time is defined as the LCD optical switching time interval between “Bright state” and “Dark state”, TR is the rise time between Luminance rate changed from 10% to 90%, TF is the fall time between Luminance rate changed

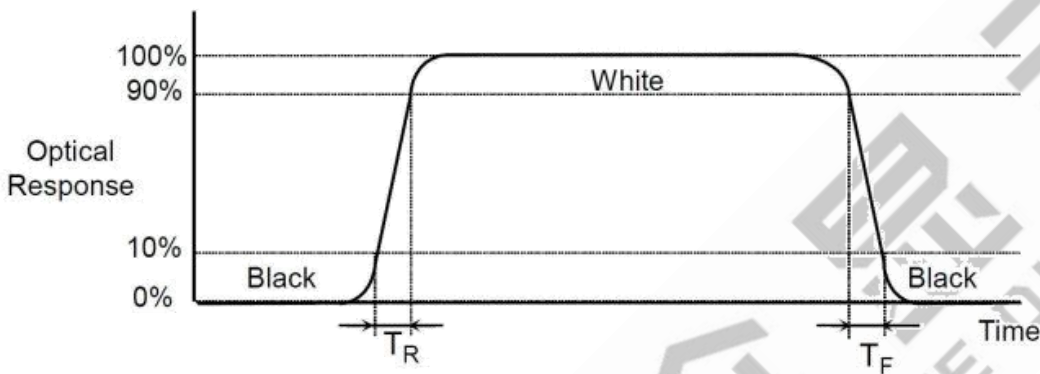

Figure 5. The definition of TR and TF

Measured response time is determined by rise time (TR) and fall time (TF), and shown in Figure 5.

(4) Definition of Viewing angle:

As CR definition is stated in Note(2), the viewing angles are defined when the viewing angle is larger than 10° in four directions relative to the perpendicular direction of the HKC’s module (two vertical angles: up θ_y+ and down θ_y- ; and two horizontal angles: right θ_x+ and left θ_x-).

The standard setup of measurement is shown in Figure 6.

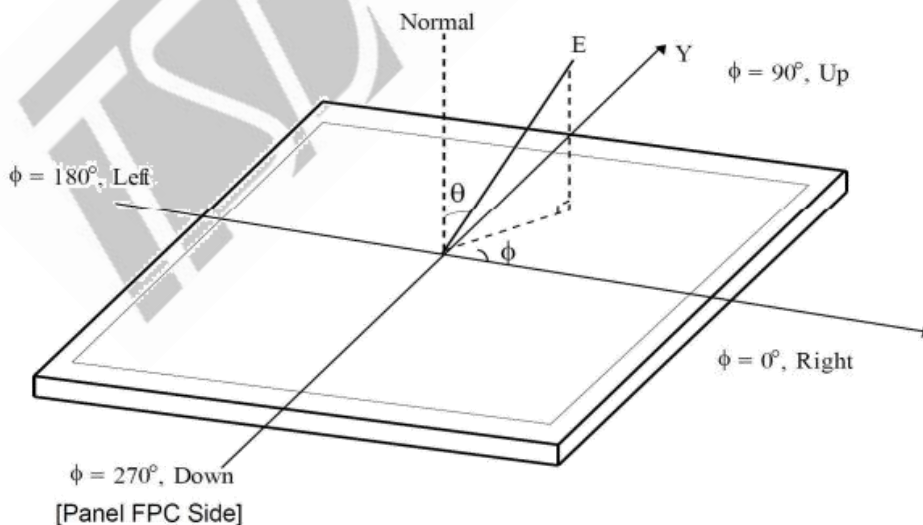

4 BLOCK DIAGRAM

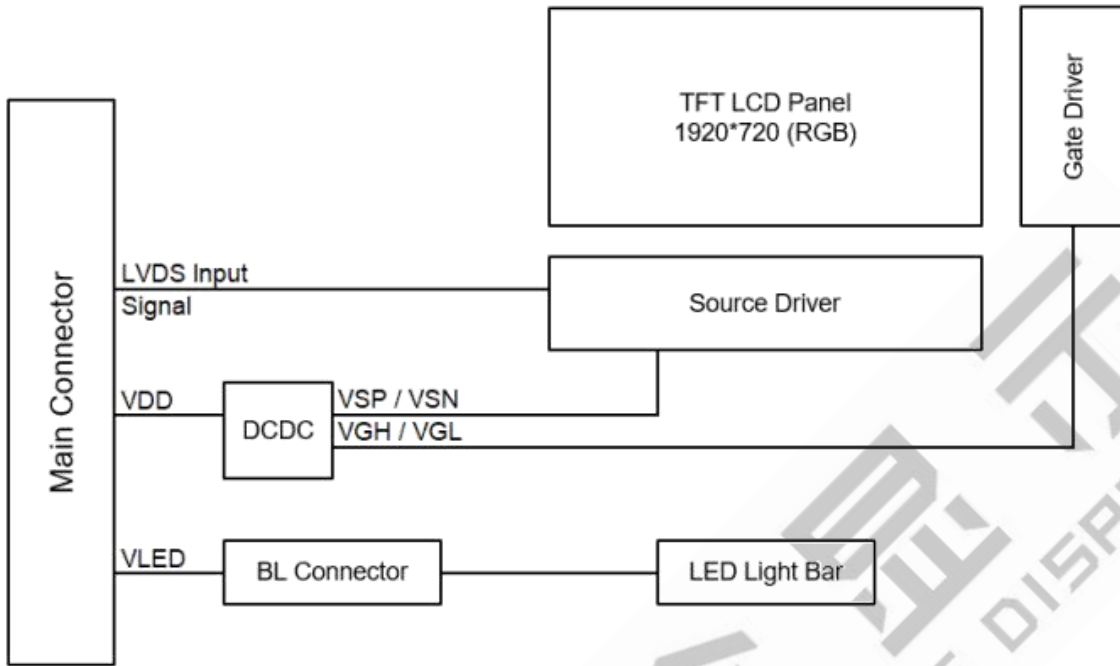

5 INTERFACE PIN CONNECTION

5.1 FPC Pin Assignment:

The electronics interface connector is 昶通 F05047-50P-U

NO.	Symbol	Functions
1	GND	Digital ground
2	BIST	LCD Panel Self Test Enable, When it is not used, connecting to GND is recommended, don't floating
3	VCC	Digital Power/Vin = 3.3V
4	VCC	Digital Power/Vin = 3.3V
5	GND	Digital ground
6	GND	Digital ground
7	OTP	Serial interface OTP power
8	NC	No connector
9	GND	Digital ground
10	ORXIN0-	Negative LVDS differential data input(Odd data)
11	ORXIN0+	Positive LVDS differential data input(Odd data)
12	ORXIN1-	Negative LVDS differential data input(Odd data)
13	ORXIN1+	Positive LVDS differential data input(Odd data)
14	ORXIN2-	Negative LVDS differential data input(Odd data)
15	ORXIN2+	Positive LVDS differential data input(Odd data)
16	ORXCLKIN-	Negative LVDS differential data input(Odd clock)
17	ORXCLKIN+	Positive LVDS differential data input(Odd clock)
18	ORXIN3-	Negative LVDS differential data input(Odd data)
19	ORXIN3+	Positive LVDS differential data input(Odd data)
20	ERXIN0-	Negative LVDS differential data input(Even data)
21	ERXIN0+	Positive LVDS differential data input(Even data)
22	ERXIN1-	Negative LVDS differential data input(Even data)
23	ERXIN1+	Positive LVDS differential data input(Even data)
24	ERXIN2-	Negative LVDS differential data input(Even data)
25	ERXIN2+	Positive LVDS differential data input(Even data)

NO.	Symbol	Functions
26	ERXCLKIN-	Negative LVDS differential data input(Even clock)
27	ERXCLKIN+	Positive LVDS differential data input(Even clock)
28	ERXIN3-	Negative LVDS differential data input(Even data)
29	ERXIN3+	Positive LVDS differential data input(Even data)
30	GND	Digital ground
31	FAULT	FAULT signal output(normal=H, abnormal=L)
32	RESET	Global reset pin, active High
33	STBYB	Standby mode, active High
34	CSB	Serial interface chip enable
35	SCL	Serial interface clock input
36	SDAI	Serial interface data input
37	SDAO	Serial interface data output
38	GND	Digital ground
39	GND	Digital ground
40	NC	No connector
41	LEDA	LED power(Anode)
42	LEDA	LED power(Anode)
43	LEDA	LED power(Anode)
44	NC	No connector
45	LEDK	Cathode1
46	LEDK	Cathode2
47	LEDK	Cathode3
48	LEDK	Cathode4
49	NTC_A	NTC_Anode
50	NTC_K	NTC_Cathode

6 ELECTRICAL CHARACTERISTICS

6.1 Absolute Maximum Ratings

The followings are maximum values which, if exceed, may cause faulty operation or damage to the unit.

The operational and non-operational maximum voltage and current values are listed as below

Parameter	Symbol	Min.	Max.	Unit	Remarks
Power Supply Voltage	V _{DD}	-0.3	4	V	1 2 3 4
Logic Supply Voltage	V _{IN}	-0.3	V _{DD} +0.3	V	
Operating Temperature	T _{OP}	-30	85	°C	
Storage Temperature	T _{ST}	-40	90	°C	

Note (1) All the parameters specified in the table are absolute maximum rating values that may cause faulty operation or unrecoverable damage, if exceeded. It is recommended to follow the typical value.

Note (2) All the contents of electro-optical specifications and display fineness are guaranteed under Normal Conditions. All the display fineness should be inspected under normal conditions. Normal conditions are defined as follow: Temperature: 25°C, Humidity: 55± 10%RH.

Note (3) Unpredictable results may occur when it was used in extreme conditions. Ta= Ambient Temperature, Tgs= Glass Surface Temperature. All the display fineness should be inspected under normal conditions.

Note (4) Temperature and relative humidity range are shown in the figure below. Wet bulb temperature should be lower than 57.8°C, and no condensation of water. Besides, protect the module from static electricity.

6.2 DC Electrical Characteristics

Parameter	Symbol	Min.	Typ.	Max.	Unit	Remarks
Power Supply Voltage	VDD	-	3.3	-	V	2
Permissible Input Ripple Voltage	VRF	-	-	200	mV	-
Power Supply Current	IDD	-	-	TBD	mA	1
Power Supply Inrush Current	Inrush	-	-	1.5	A	2
Power Consumption	Mosaic	-	-	TBD	W	1

Notes :

1. The supply voltage is measured and specified at the interface connector of LCM.

The current draw and power consumption specified is for 3.3V at 25 °C.

Mosaic 7*5 pattern

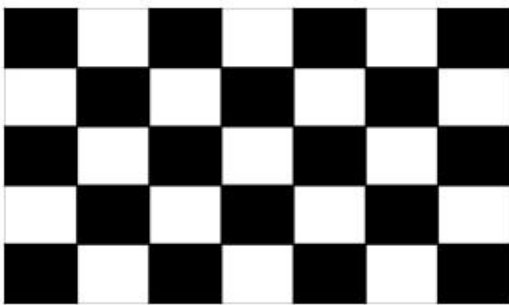

2. Measure condition :

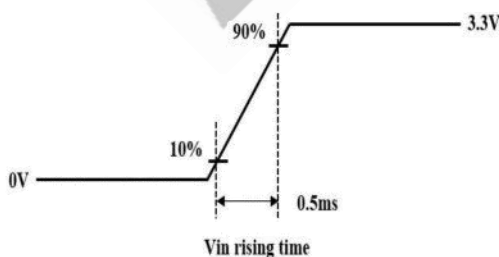

6.3 Measurement Conditions

The table below is the test condition of optical measurement

Item	Symbol	Value	Unit
Ambient Temperature	T _A	23±5	°C
Ambient Humidity	H _A	50±20	% RH
Supply Voltage	V _{CC}	3.3	V
Driving Signal	Refer to the typical value in Chapter 3: Electrical Specification		
Vertical Refresh Rate	F _v	60	Hz
Warm up time	T _{warm}	> 15 min	Min
Dark room	ED	< 1 Lux	Lux

6.4 Signal Timing Specification

Parameter	Symbols	Panel Resolution			Unit
		1920RGB*720 (2 port)			
		Min.	Typ.	Max.	
DCLK frequency	F _{dclk}	-	45.3	-	MHz
Horizontal valid data	T _{hd}	-	960	-	DCLK
1 horizontal line	T _h	1015	1026	1248	DCLK
Vertical valid data	T _{vd}	-	720	-	H
1 vertical field	T _v	730	736	756	H
Frame rate	FR	-	60	-	Hz

6.5 Signal Electrical Characteristics for LVDS Receiver

The built-in LVDS receiver is compatible with (ANSI/TIA/TIA-644) standard.

Parameter	Symbol	Condition	Specification			Unit
			Min.	Typ.	Max.	
Differential input high Threshold voltage	V _{th}	V _{cm} = 1.2V	0.1	-	-	
Differential input low Threshold voltage	V _{tl}	V _{cm} = 1.2V	-	-	0.1	
Differential input common Mode voltage	V _{CM}	-	1	1.2	1.7 - V _{id} / 2	
LVDS input voltage	V _{INLV}	-	0.7	-	1.7	
Differential input voltage	V _{id}	-	0.1	-	0.6	
Differential input leakage current	I _{lvleak}	-	-10	-	10	

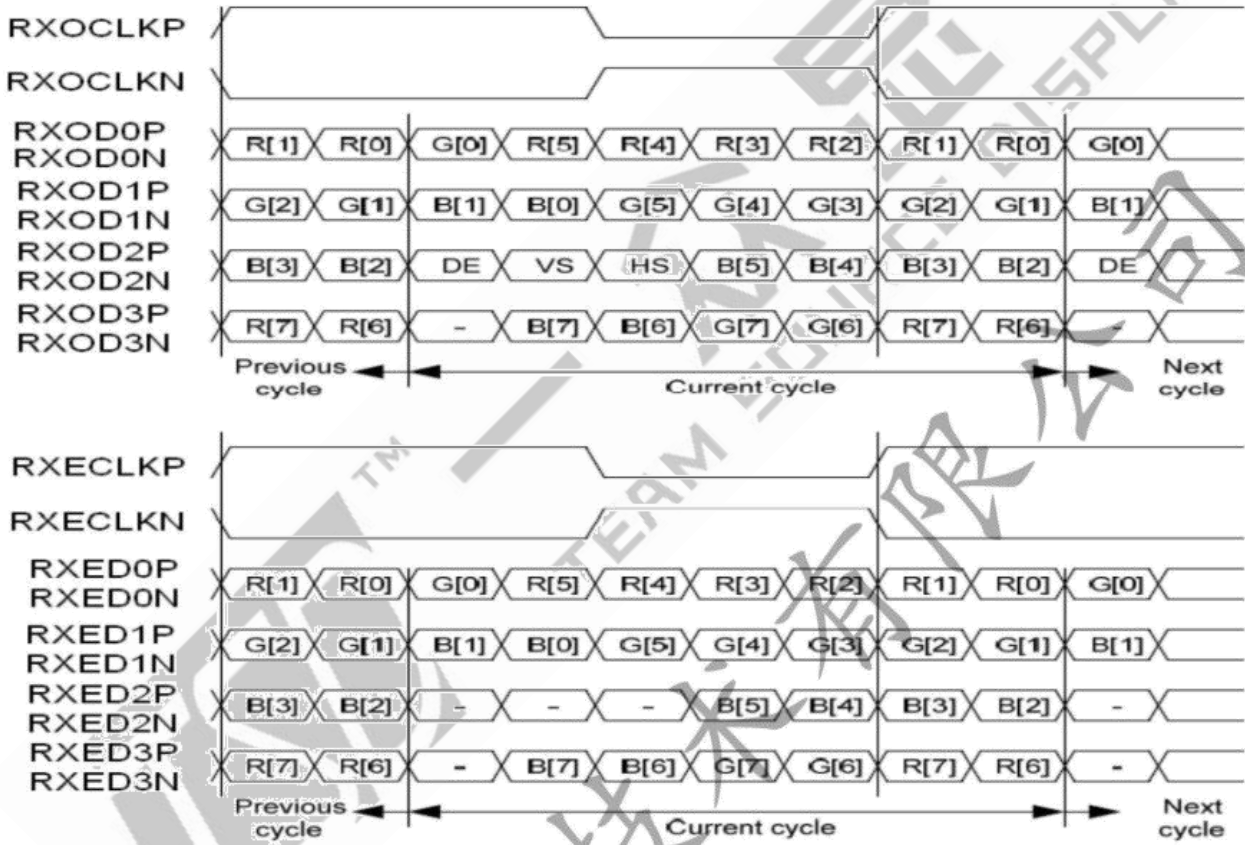
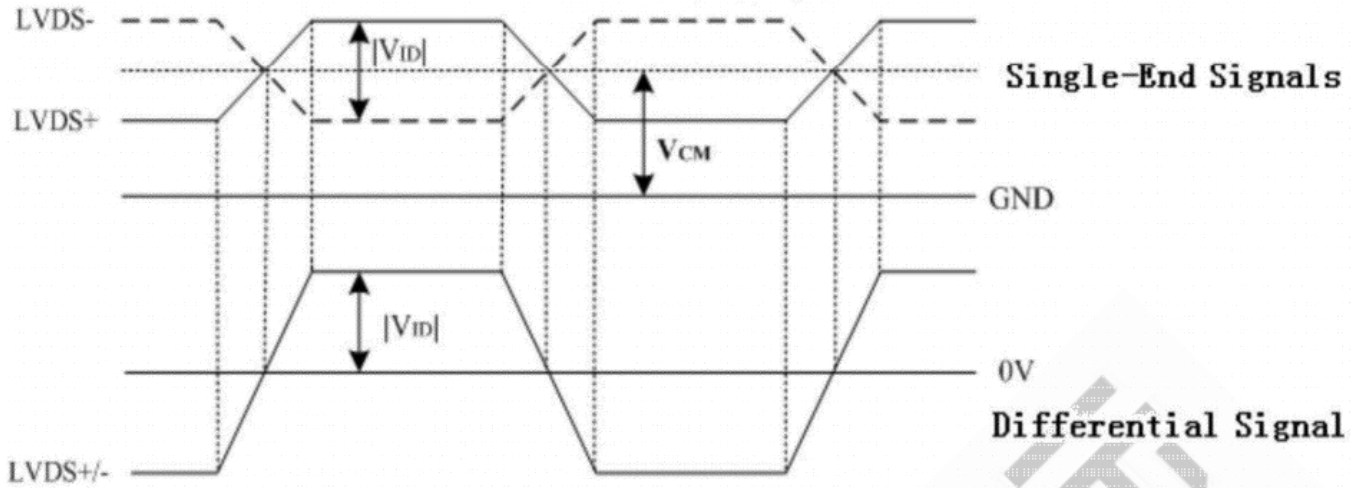

6.6 POWER SEQUENCE

prevent a latch-up or DC operation of the LCD module, the power on/off sequence shall be as shown in below.

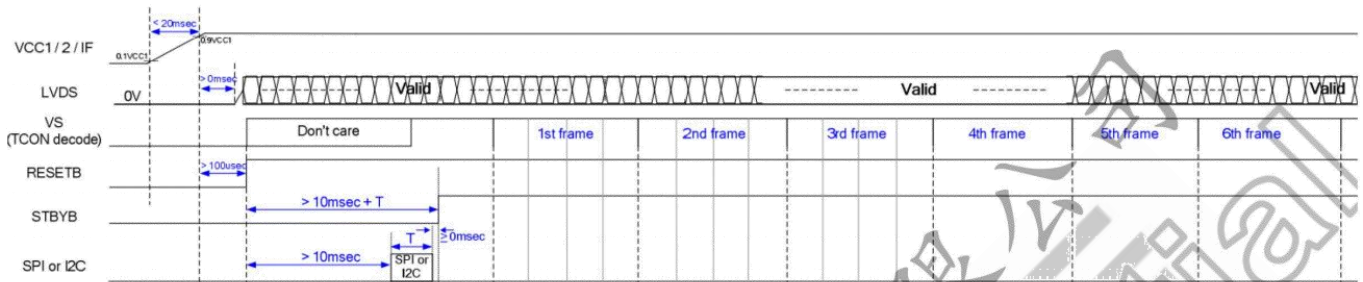

Power-on Sequence

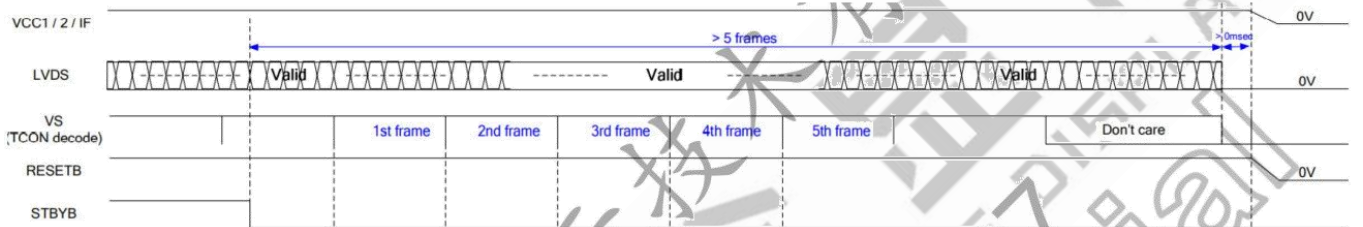

Power-off Sequence

6.7 DC Characteristics Backlight Driving

Parameter	Symbol	Min	Typ	Max	Units	Condition
LED Current	I_F	-	360	-	mA	$T_a=25^\circ\text{C}$
LED Voltage	V_F	18.9	21	23.8	Volt	$T_a=25^\circ\text{C}$
LED Life-Time	N/A	30000	--	--	Hour	$T_a=25^\circ\text{C}$ $I_F=90\text{mA}$

Note (1) LED life time (Hr) can be defined as the time in which it continues to operate under the condition: $T_a=25\pm 3\text{ }^\circ\text{C}$, typical IL value indicated in the above table until the brightness becomes less than 50%.

Note (2) The “LED life time” is defined as the module brightness decrease to 50% original brightness at $T_a=25^\circ\text{C}$ and $I_L= 360\text{ mA}$. The LED lifetime could be decreased if operating I_L is larger than 360 mA. The constant current driving method is suggested.

Note (3) LED Light Bar Circuit 7 S4P = 28 pcs LED

LED Source(CIRCUIT DIAGRAM)

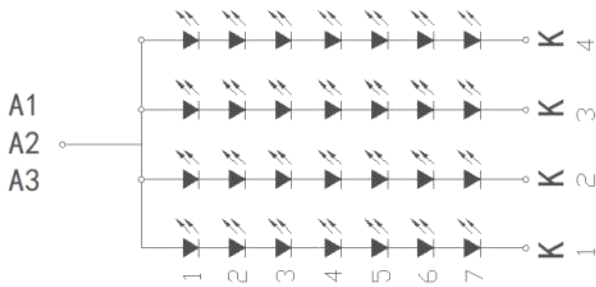

村田 : NCU15XH103F6SRC

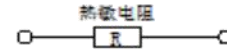

NTC 电路图

Pin assignment for Back light :

NO.	Symbol	Description
1	A1	Power LED anode power supply (+)
2	A2	Power LED anode power supply (+)
3	A3	Power LED anode power supply (+)
4	NC	No connection
5	K1	Power LED cathode power supply (-)
6	K2	Power LED cathode power supply (-)
7	K3	Power LED cathode power supply (-)
8	K4	Power LED cathode power supply (-)
9	NTC1	Thermistor(+)
10	NTC2	Thermistor(-)

NTC information :

Item	Value	Remark
Part number	NCU15XH103F6SRC	Murata
Resistance / Tolerance	10KΩ+/- 1%	Ta = 25°C
Permissive Operating Current (Max.)	0.31 mA	

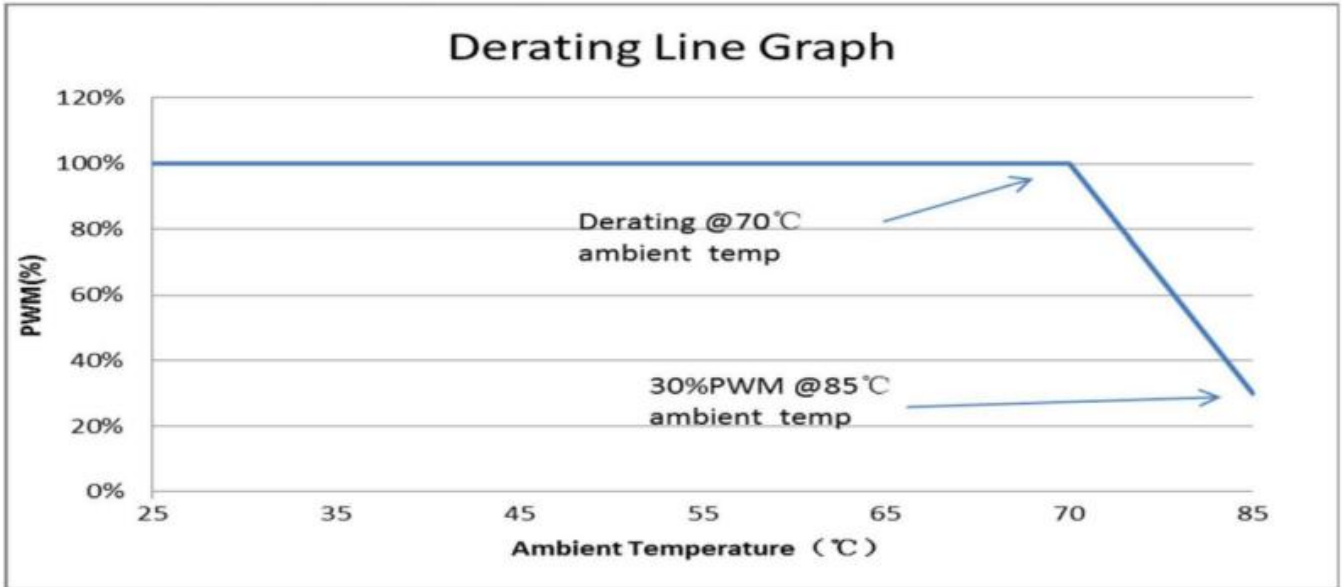

Thermistor Description

TEMP. (deg.C)	R-center (k ohm)	TEMP. (deg.C)	R-center (k ohm)	TEMP. (deg.C)	R-center (k ohm)	TEMP. (deg.C)	R-center (k ohm)	TEMP. (deg.C)	R-center (k ohm)
-40	195.652	-2	29.689	36	6.707	74	1.981	112	0.722
-39	184.917	-1	28.423	37	6.475	75	1.925	113	0.705
-38	174.845	0	27.219	38	6.253	76	1.870	114	0.688
-37	165.391	1	26.076	39	6.039	77	1.817	115	0.672
-36	156.513	2	24.988	40	5.834	78	1.766	116	0.656
-35	148.171	3	23.951	41	5.636	79	1.716	117	0.640
-34	140.330	4	22.963	42	5.445	80	1.669	118	0.625
-33	132.958	5	22.021	43	5.262	81	1.622	119	0.611
-32	126.022	6	21.123	44	5.086	82	1.578	120	0.596
-31	119.494	7	20.267	45	4.917	83	1.535	121	0.583
-30	113.347	8	19.450	46	4.754	84	1.493	122	0.569
-29	107.565	9	18.670	47	4.597	85	1.452	123	0.556
-28	102.116	10	17.926	48	4.446	86	1.413	124	0.544
-27	96.978	11	17.214	49	4.301	87	1.375	125	0.531
-26	92.132	12	16.534	50	4.161	88	1.338	126	0.519
-25	87.559	13	15.886	51	4.026	89	1.303	127	0.507
-24	83.242	14	15.266	52	3.896	90	1.268	128	0.496
-23	79.166	15	14.674	53	3.771	91	1.234	129	0.485
-22	75.316	16	14.108	54	3.651	92	1.202	130	0.474
-21	71.677	17	13.566	55	3.535	93	1.170	131	0.464
-20	68.237	18	13.049	56	3.423	94	1.139	132	0.454
-19	64.991	19	12.554	57	3.315	95	1.110	133	0.444
-18	61.919	20	12.081	58	3.211	96	1.081	134	0.434
-17	59.011	21	11.628	59	3.111	97	1.053	135	0.424
-16	56.258	22	11.195	60	3.014	98	1.026	136	0.415
-15	53.650	23	10.780	61	2.922	99	0.999	137	0.406
-14	51.178	24	10.382	62	2.834	100	0.974	138	0.397
-13	48.835	25	10.000	63	2.748	101	0.949	139	0.389
-12	46.613	26	9.634	64	2.666	102	0.925	140	0.381
-11	44.506	27	9.284	65	2.586	103	0.902	141	0.373
-10	42.506	28	8.947	66	2.509	104	0.880	142	0.365
-9	40.600	29	8.624	67	2.435	105	0.858	143	0.357
-8	38.791	30	8.315	68	2.364	106	0.837	144	0.350
-7	37.073	31	8.018	69	2.294	107	0.816	145	0.342
-6	35.442	32	7.734	70	2.228	108	0.796	146	0.335
-5	33.892	33	7.461	71	2.163	109	0.777	147	0.328
-4	32.420	34	7.199	72	2.100	110	0.758	148	0.322
-3	31.020	35	6.948	73	2.040	111	0.740	149	0.315

LED forward current should follow the De-rating curve.

MK-4014 Life Curves

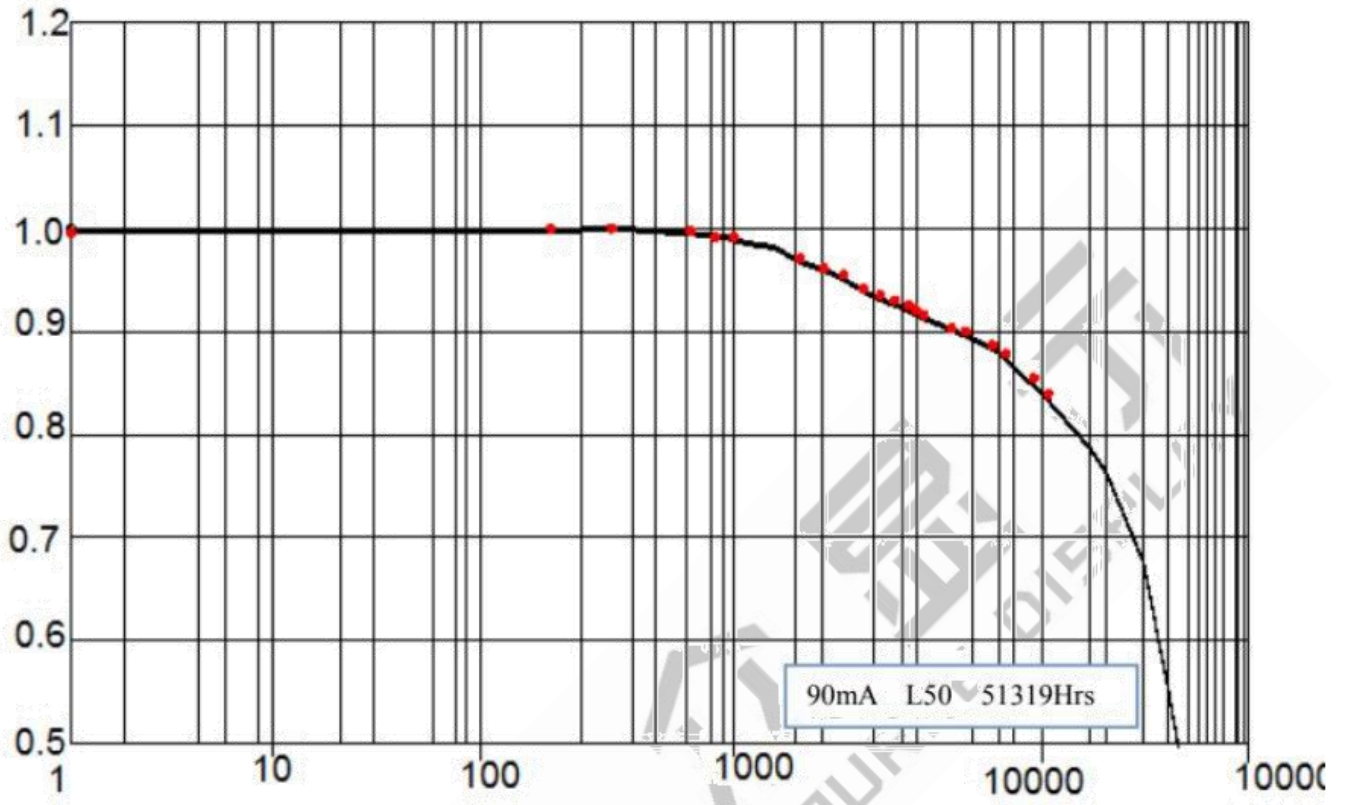

7 RELIABILITY TEST ITEMS

NO.	TEST ITEM	TEST CONDITION	INSPECTION AFTER TEST
1	High Temperature Storage	90°C/500 hours	Inspection after 2~4 hours storage at room temperature and humidity. The condensation is not accepted. The sample shall be free from defects: 1. Air bubble in the LCD 2. Seal leak 3. Non-display 4. Missing segments 5. Glass crack
2	Low Temperature Storage	-40°C/500 hours	
3	High Temperature Operating	85°C/500 hours	
4	Low Temperature Operating	-30°C/500 hours	
5	Temperature Cycle	-40°C ~ 25~ 85°C × 100 cycles (30 min.) (5min.) (30min.)	
6	Damp Proof Test	60°C ±5°C × 90%RH/500 hours	
7	Vibration Test	Frequency 10Hz~55Hz Stroke: 1.5mm Sweep: 10Hz~150 Hz~10Hz 2 hours For each direction of X, Y, Z	
8	Packing Drop Test	Height: 60 cm 1 corner, concrete floor	
9	Electrostatic Discharge Test	C=150pF, R=330 Ω Air: ±8KV 150pF/330Ω 30 times Contact: ±4KV,20 times	
10	Image Sticking	25°C,60%RH (ref.to Remark(1))/30 minutes	

Remark (1): Switch the image to Grey 127 after displaying the 5*8 chess pattern for 30 minutes, the afterimage disappears within 10 seconds.

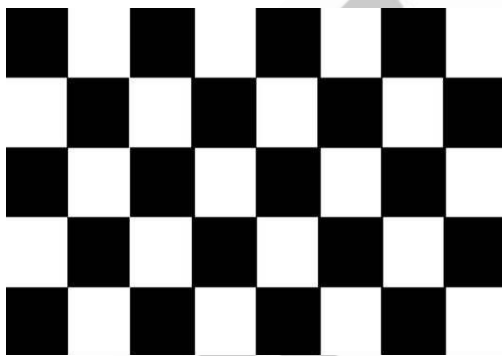

5*8 chess pattern



Gray127

8 OUTLINE DIMENSION

LED 电路图
料号: NCU15H100P8SRC

NTC 电路图

背光源 FPC PIN 定义

PIN	Symbol	Description
1	V11	AVDD (+3)
2	V2	AVDD (+3)
3	V3	AVDD (+3)
4	NC	NO CONNECTION
5	V17	CAVDD (+3)
6	R2	CAVDD (+3)
7	V3	CAVDD (+3)
8	V31	CAVDD (+3)
9	V20	CAVDD (+3)

背光源 FPC PIN 定义

PIN	NAME	PIN	NAME	PIN	NAME
1	Q10	16	BPCLKIN+	31	FAULT
2	BIST	17	BPCLKIN+	32	RESET
3	VCC	18	BPDM+	33	STB/B
4	VCC	19	BPDM+	34	CSB
5	Q10	20	BPDM+	35	SCL
6	Q10	21	BPDM+	36	SDA
7	Q1P	22	EPDM+	37	SMO
8	NC	23	EPDM+	38	Q10
9	Q10	24	EPDM+	39	Q10
10	BPDM+	25	EPDM+	40	NC
11	BPDM+	26	EPCLKIN+	41	LED+
12	EPDM+	27	EPCLKIN+	42	LED+
13	EPDM+	28	EPDM+	43	LED+
14	BPDM+	29	EPDM+	44	NC
15	BPDM+	30	Q10	45	LED+

NOTES:

1. GENERAL TOLERANCE: ± 0.3
2. () REFERENCE DIMENSION
3. Important dimension: ①~③

FPC 端子正面放大图

变更记录 (Revise History)

版本 (Version)	Initial release	日期 (Date)
A0		2021.07.01

设计 (DESIGN)

审核 (CHECKED)	批准 (APPROVED)	客户承认 (CUSTOMER APPROVAL)
Alton	Alton	

标题 (TITLE)

LCM

规格 (Spec) | 1 / 1

比例 (SCALE) | 1 : 1

图号 (Part No.) | TST103HDKK-02

9 About Image Sticking

9.1.1 What is Image Sticking?

If you remain a fixed image on LCD Display for a long period of time, you may experience a phenomenon called Image Sticking. Image Sticking - sometimes also called “image retention” or “ghosting” - is a phenomenon where a faint outline of a previously displayed image remains visible on the screen when the image is changed. It can occur at variable levels of intensity depending on the specific image makeup, as well as the amount of time the core image elements are allowed to remain unchanged on the screen. In POS applications, for example, a button menu which remains fixed, or in which the “frame” elements (core image) remain fixed and the buttons may change, may be susceptible to image sticking. It is important to note that if the screen is used exclusively for this application, the user may never notice this phenomenon since the screen never displays other content. It is only when an image other than the “retained” image is shown on the screen that this issue becomes evident. Image sticking is different that the “burn-in” effect commonly associated with phosphor based devices.

9.1.2 What causes Image Sticking?

Image sticking is an intrinsic behavior of LCD displays due to the susceptibility to polarization of the interior materials (liquid crystals) when used under static, charged conditions (continuously displaying the same image). The individual liquid crystals in an LCD panel have unique electrical properties. Displaying a fixed pattern - such as the POS menu described above - over prolonged periods can cause a parasitic charge build-up (polarization) within the liquid crystals which affects the crystals’ optical properties and ultimately prevents the liquid crystal from returning to its normal, relaxed state when the pattern is finally changed. This effect takes place at a cellular level within the LCD, and the effect can cause charged crystal alignment at the bottom or top of a crystal cell in the “z” axis, or even crystal migration to the edges of a cell, again based on their polarity. These conditions can cause image sticking over an entire area, or at boundaries of distinct color change respectively. In either case, when the liquid crystals in the pixels and sub-pixels utilized to display the static image are polarized such that they can not return fully to their “relaxed” state upon deactivation, the result is a faint, visible, retained image on the panel upon presentation of a new, different image. The actual rate of image retention depends on variation factors such as the specific image, how long it is displayed unchanged, the temperature within the panel and even the specific panel brand due to manufacturing differences amongst panel manufacturers.

9.1.3 How to Avoid Image Sticking?

- Try not to operate the LCD with a “fixed” image on the screen for more than 1 hours.
- If you are operating the monitor in an elevated temperature environment and with a displayed image which is contrary to the recommendations in “For Software Developers” below, image stick can occur in as little as 30 minutes. Adjust your screen saver settings accordingly.
- Power down the unit during prolonged periods of inactivity such as the hours a store is closed or a shift during which the piece of equipment isn’t used.
- Use a screensaver with a black or medium gray background that is automatically set to come on if the device is inactive for more than 5-10 minutes.
- Avoid placing the monitor in poorly ventilated areas or in areas that will create excess heat around the monitor for software developers.
- In defining the icons, buttons, or windows in the screen, try to utilize block patterns instead of distinct lines as borders for dividing the display into distinct areas.
- If it is necessary to display a static image, try to use colors that are symmetric to the middle grey level at the boundary of two different colors, and slightly shift the borders line once in a while.
- Try to utilize medium gray hues for those areas that will have prolonged display times or remain static

as other menu elements change.

9.1.4 How to Fix the Image Sticking?

Unlike the usually irreversible “burn-in” effects commonly associated with direct view phosphor display devices such as CRTs, an image retained on an LCD display can be reversed – often to a point of total invisibility. However, the severity of the underlying causes (as described above) of the image retained on a specific display, as well as the variation factors (see “For Software Developers” above) under which the retained image was created, will dictate the final level of retention reversal. One way to erase a retained image on a panel is to run the screen (monitor “on”) in an “all black” pattern for 4-6 hours. It is also helpful to do this in an elevated temperature environment of approximately 35° to 50° C. Again, utilizing a dynamic screen saver with an all black background during prolonged idle display periods is a good way to avoid image retention issues.

9.1.5 Is Image Sticking Covered by TSD RMA Warranty?

Image sticking is a phenomenon inherent to LCD Display technology itself, and as such, the occurrence of this “ghosting” effect is considered normal operation by the manufacturers of the LCD display modules which are integrated into today’s monitor solutions. TSD does not warrant any display against the occurrence of image sticking. We strongly advise that you follow the operating recommendations listed above to avoid the occurrence of this phenomenon.

9.2 Others

1. Issues that are not defined in this document shall be discussed and agreed with both parties. (Customer and supplier)
2. Unless otherwise agreed upon in writing, the criteria shall be applied to both parties. (Customer and supplier)

10 Suggestions for using LCD modules

10.1 Handling of LCM

1. The LCD screen is made of glass. Don't give excessive external shock, or drop from a high place.
2. If the LCD screen is damaged and the liquid crystal leaks out, do not lick and swallow. When the liquid is attach to your hand, skin, cloth etc, wash it off by using soap and water thoroughly and immediately.
3. Don't apply excessive force on the surface of the LCM.
4. If the surface is contaminated, clean it with soft cloth. If the LCM is severely contaminated, use Isopropyl alcohol/Ethyl alcohol to clean. Other solvents may damage the polarizer. The following solvents is especially prohibited: water , ketone Aromatic solvents etc.
5. Exercise care to minimize corrosion of the electrode. Corrosion of the electrodes is accelerated by water droplets, moisture condensation or a current flow in a high-humidity environment.
6. Install the LCD Module by using the mounting holes. When mounting the LCD module make sure it is free of twisting, warping and distortion. In particular, do not forcibly pull or bend the I/O cable or the backlight cable.
7. Don't disassemble the LCM.
8. To prevent destruction of the elements by static electricity, be careful to maintain an optimum work environment.
 - Be sure to ground the body when handling the LCD modules.
 - Tools required for assembling, such as soldering irons, must be properly grounded.
 - To reduce the amount of static electricity generated, do not conduct assembling and other work under dry conditions.
 - The LCD module is coated with a film to protect the display surface. Exercise care when peeling

off this protective film since static electricity may be generated.

9. Do not alter, modify or change the the shape of the tab on the metal frame.
10. Do not make extra holes on the printed circuit board, modify its shape or change the positions of components to be attached.
11. Do not damage or modify the pattern writing on the printed circuit board.
12. Absolutely do not modify the zebra rubber strip (conductive rubber) or heat seal connector
13. Except for soldering the interface, do not make any alterations or modifications with a soldering iron.
14. Do not drop, bend or twist LCM.

10.2 Storage

1. Store in an ambient temperature of 5 to 45 °C, and in a relative humidity of 40% to 60%. Don't expose to sunlight or fluorescent light.
2. Storage in a clean environment, free from dust, active gas, and solvent.
3. Store in antistatic container.

11 Limited Warranty

- 1.Our warranty liability is limited to repair and/or replacement. We will not be responsible for any consequential loss.
- 2.If possible, we suggest customer to use up all LCD modules as soon as possible. If the LCD module storage time over twelve months, we suggest to recheck it before being used.
- 3.Any product issues must be feedback to TSD within 12 months since delivery, otherwise, we will not be responsible for the subsequent or consequential events.